

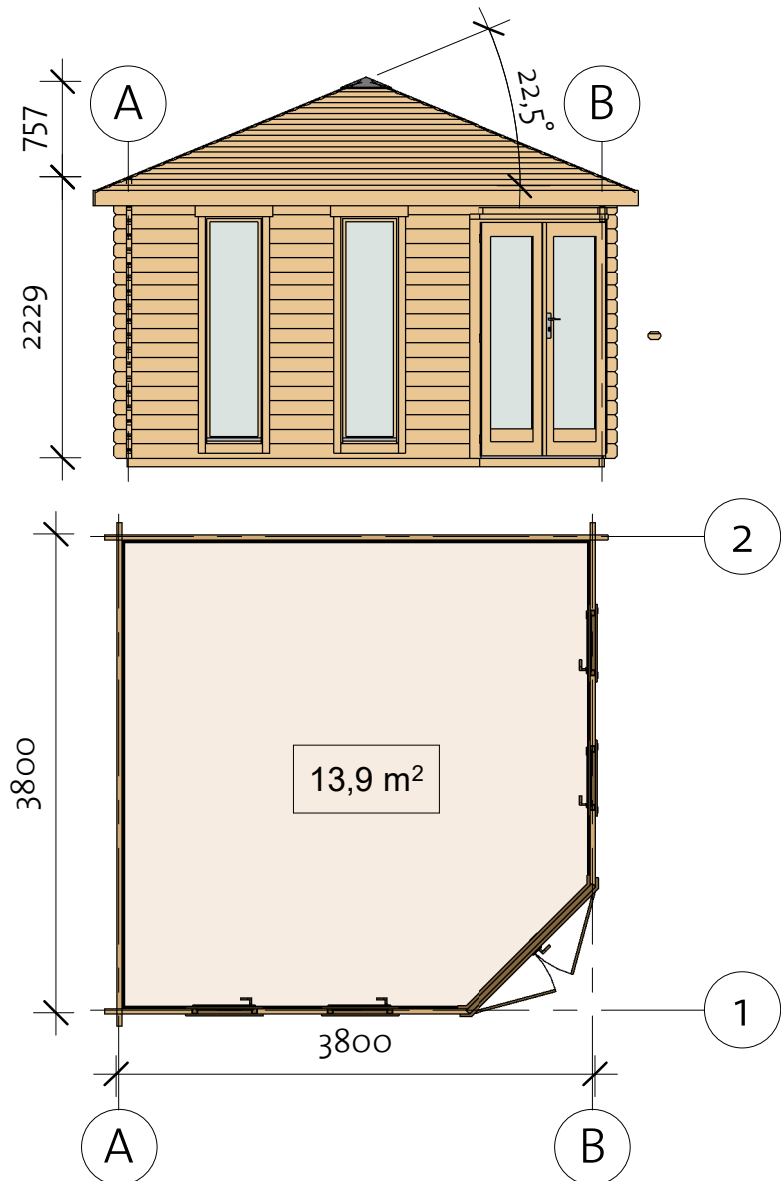

c.Arboga II 40 (380x380)

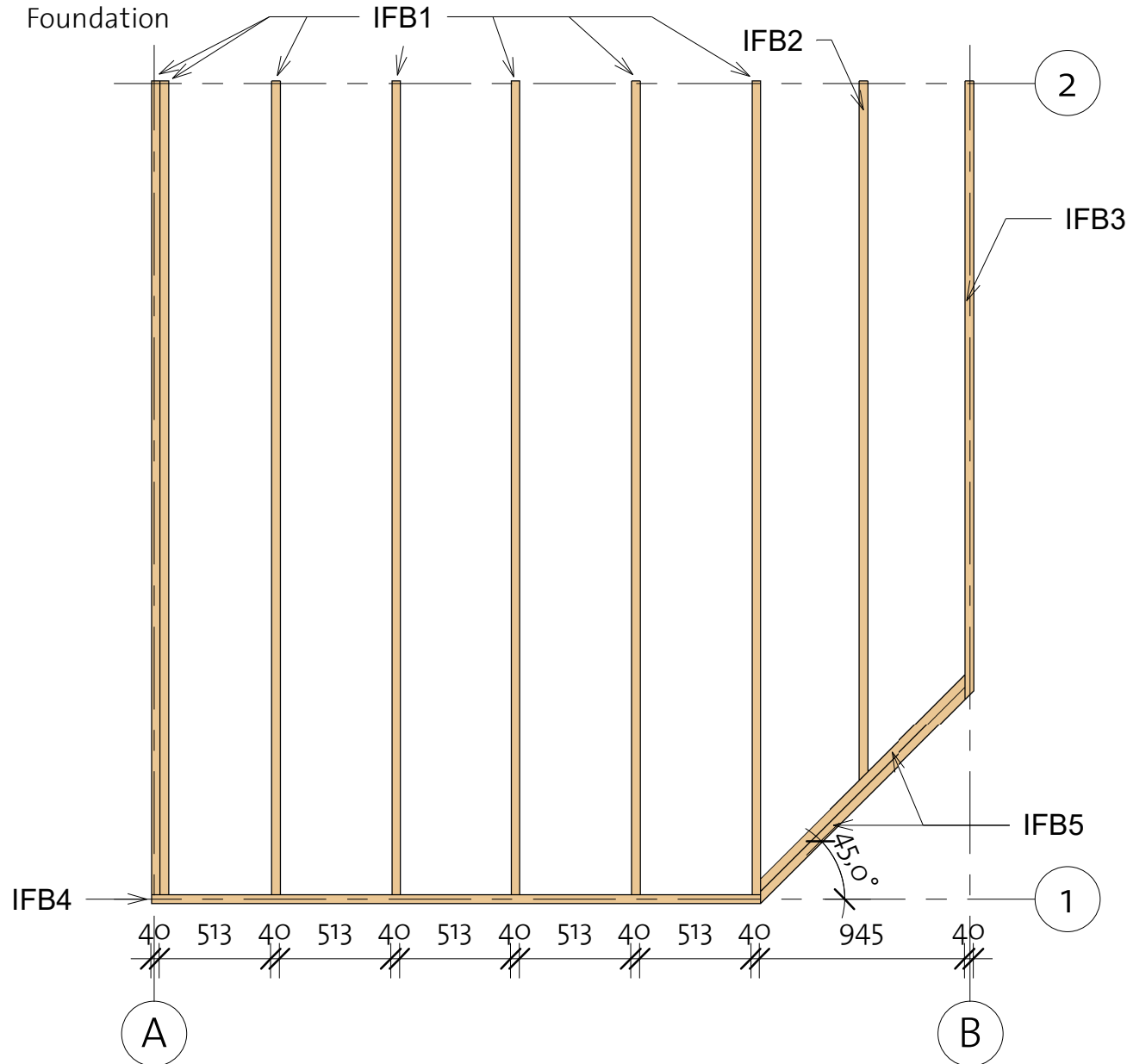

c.Arboga II 40 (380x380)



Impregnated foundation beams				
Mark	Type	Profile	Count	Length
IFB1	IFB 40x70		7	3750
IFB2	IFB 40x70		1	3224
IFB3	IFB 40x70		1	2845
IFB4	IFB 40x70		1	2805
IFB5	IFB 40x70		2	1376

c.Arboga II 40 (380x380)

Floor Plan

① Baseboard

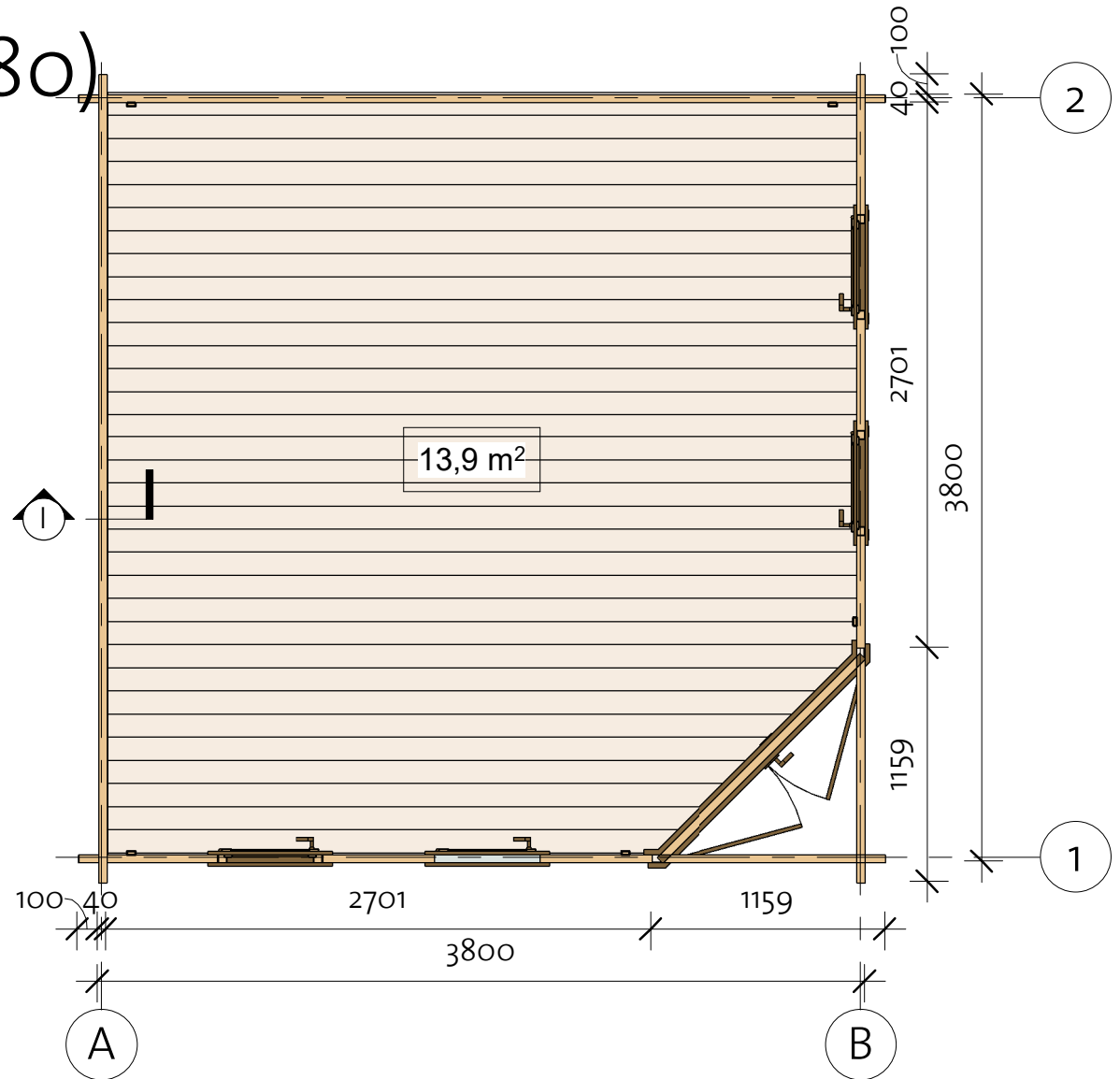
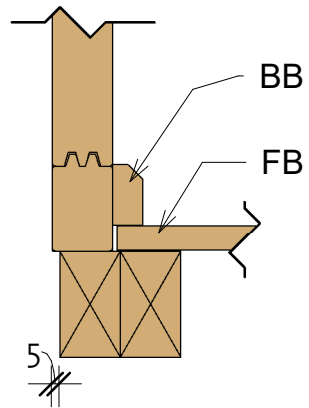

Floor Schedule

Mark	Type	Profile	Count	Length
------	------	---------	-------	--------

FB 1	FB 17x114		1	2861
FB 2	FB 17x114		1	2975
FB 3	FB 17x114		1	3089
FB 4	FB 17x114		1	3203
FB 5	FB 17x114		1	3317
FB 6	FB 17x114		1	3431
FB 7	FB 17x114		1	3545
FB 8	FB 17x114		1	3659
FB 9	FB 17x114		1	3717
FB 10	FB 17x114		25	3717

BB	BB 20x40		4	3800
----	----------	--	---	------

c.Arboga II 40 (380x380)

Wall 1

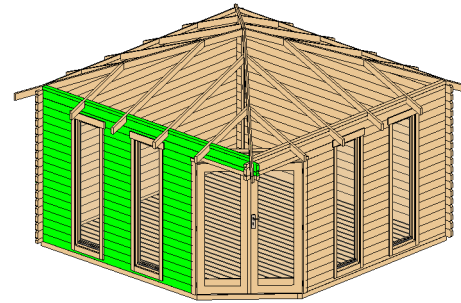

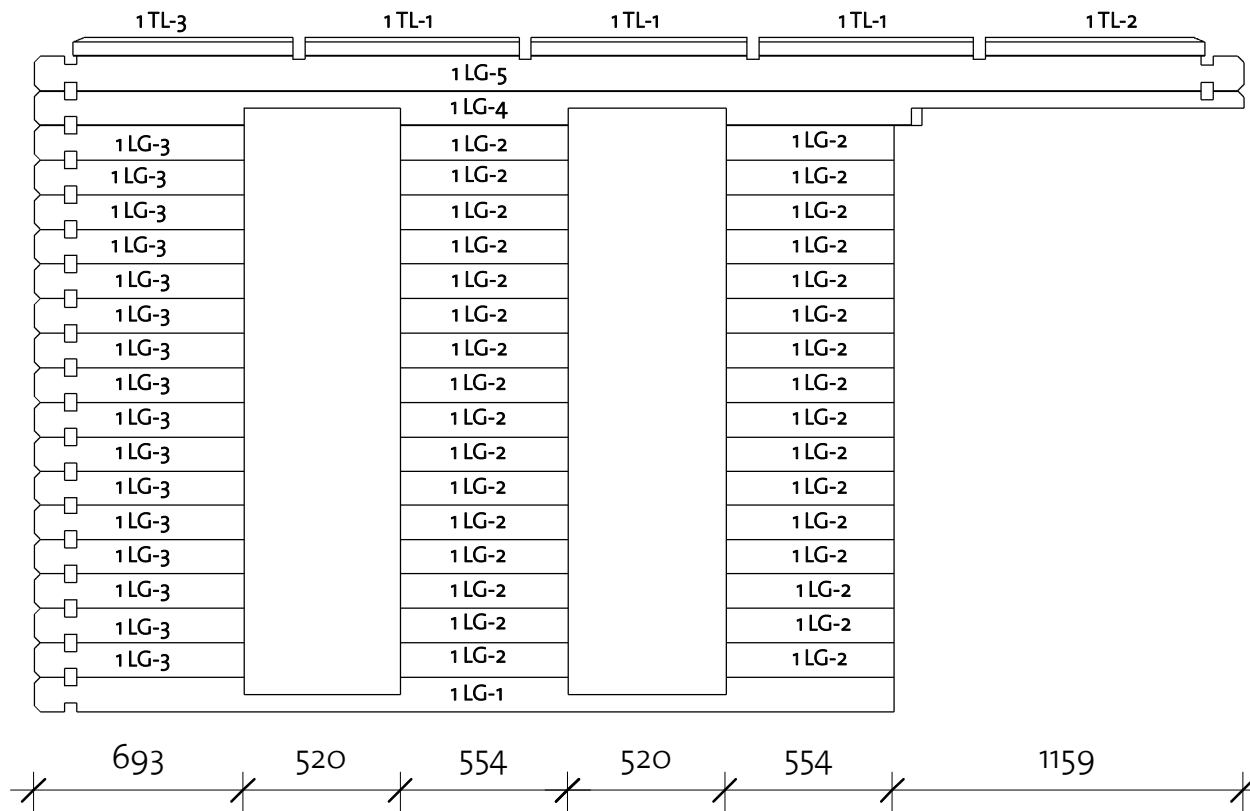

Wall 1			
Mark	Profile	Count	Cut Length

1LG-1	40x114	1	2841
1LG-2	40x114	32	554
1LG-3	40x114	16	693
1LG-4	40x114	1	4000
1LG-5	40x114	1	4000
1TL-1	40x63	3	711
1TL-2	40x63	1	725
1TL-3	40x63	1	725

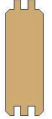

Log Profile Wall 1	
Profile	Profile

40x114	
40x63	

c.Arboga II 40 (380x380)

Wall 2

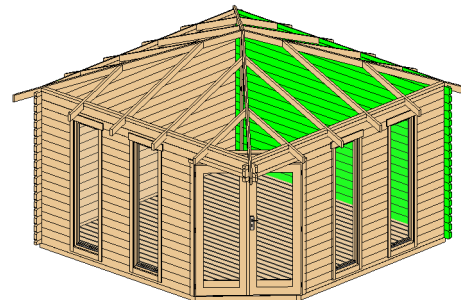

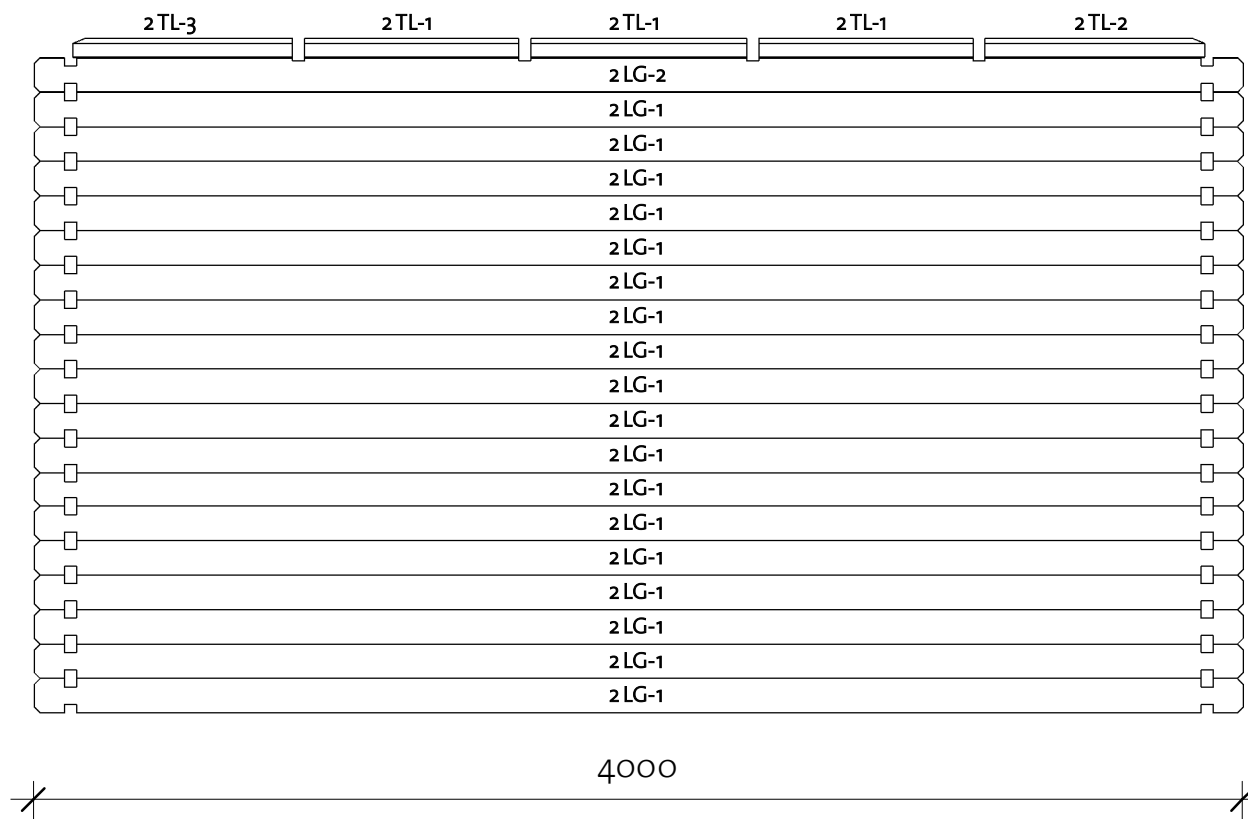

Wall 2			
Mark	Profile	Count	Cut Length

2LG-1	40x114	18	4000
2LG-2	40x114	1	4000
2TL-1	40x63	3	711
2TL-2	40x63	1	725
2TL-3	40x63	1	725



Log Profile Wall 2	
Profile	Profile

40x114	
40x63	

c.Arboga II 40 (380x380)

Wall B

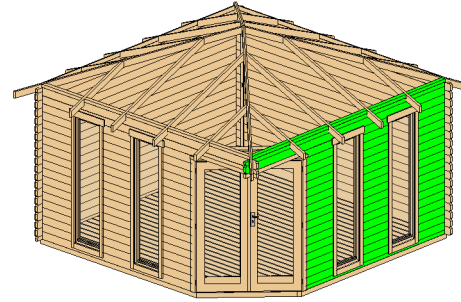

Wall B			
Mark	Profile	Count	Cut Length

BTL-1	40x63	3	711
BTL-2	40x63	1	725
BTL-3	40x63	1	725
BBL-1	40x57	1	2841
BLG-1	40x114	33	554
BLG-2	40x114	1	4000
BLG-3	40x114	1	651
BLG-4	40x114	17	693
BLG-5	40x57 TL	1	4000

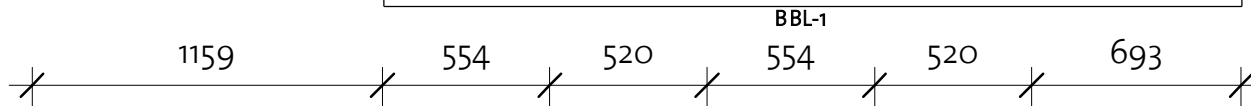
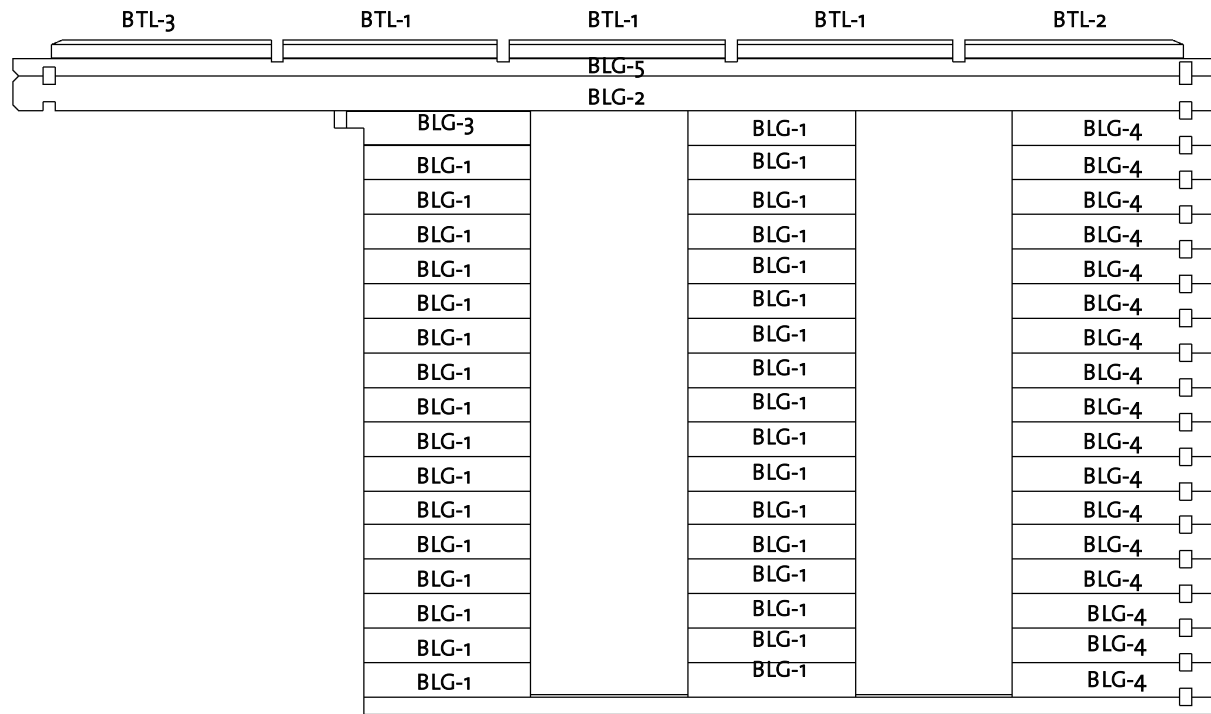

Log Profile Wall B	
Profile	Profile

Log Profile Wall B	
Profile	Profile

40x57	
40x57 TL	

40x63	
40x114	

c.Arboga II 40 (380x380)

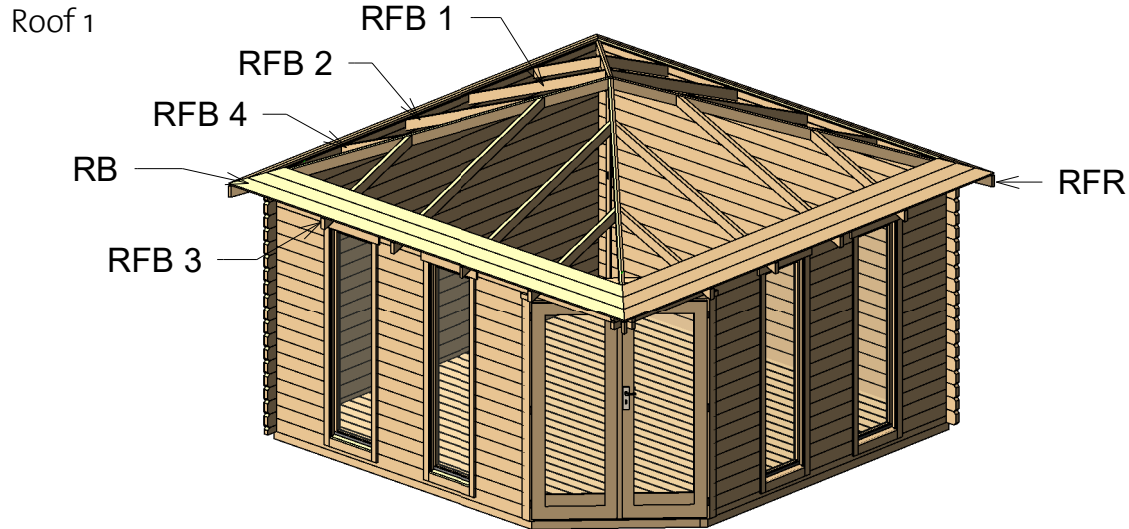

Roof				
Mark	Type	Profile	Count	Length

RFR	40x94		4	3172
RFB4	40x85		4	1132
RFB3	40x85		4	1132
RFB2	40x85		4	1945
RFB1	40x85		4	1945

Roofboards				
Mark	Type	Profile	Count	Length

RB 1	RoofBoard 17x114		4	292
RB 2	RoofBoard 17x114		4	503
RB 3	RoofBoard 17x114		4	714
RB 4	RoofBoard 17x114		4	924
RB 5	RoofBoard 17x114		4	1135
RB 6	RoofBoard 17x114		4	1345
RB 7	RoofBoard 17x114		4	1556
RB 8	RoofBoard 17x114		4	1767
RB 9	RoofBoard 17x114		4	1977

Roofboards				
Mark	Type	Profile	Count	Length

RB 10	RoofBoard 17x114		4	2188
RB 11	RoofBoard 17x114		4	2399
RB 12	RoofBoard 17x114		4	2609
RB 13	RoofBoard 17x114		4	2820
RB 14	RoofBoard 17x114		4	3031
RB 15	RoofBoard 17x114		4	3241
RB 16	RoofBoard 17x114		4	3452
RB 17	RoofBoard 17x114		4	3663
RB 18	RoofBoard 17x114		4	3873
RB 19	RoofBoard 17x114		4	4084
RB 20	RoofBoard 17x114		4	4294

c.Arboga II 40 (380x380)

Roof 2

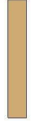
Fascia Schedule				
Mark	Type	Profile	Count	Length
RF	Roof Fascia 18x120		4	4314

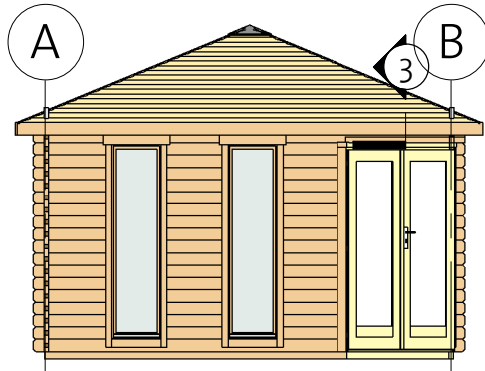

3) Fascia

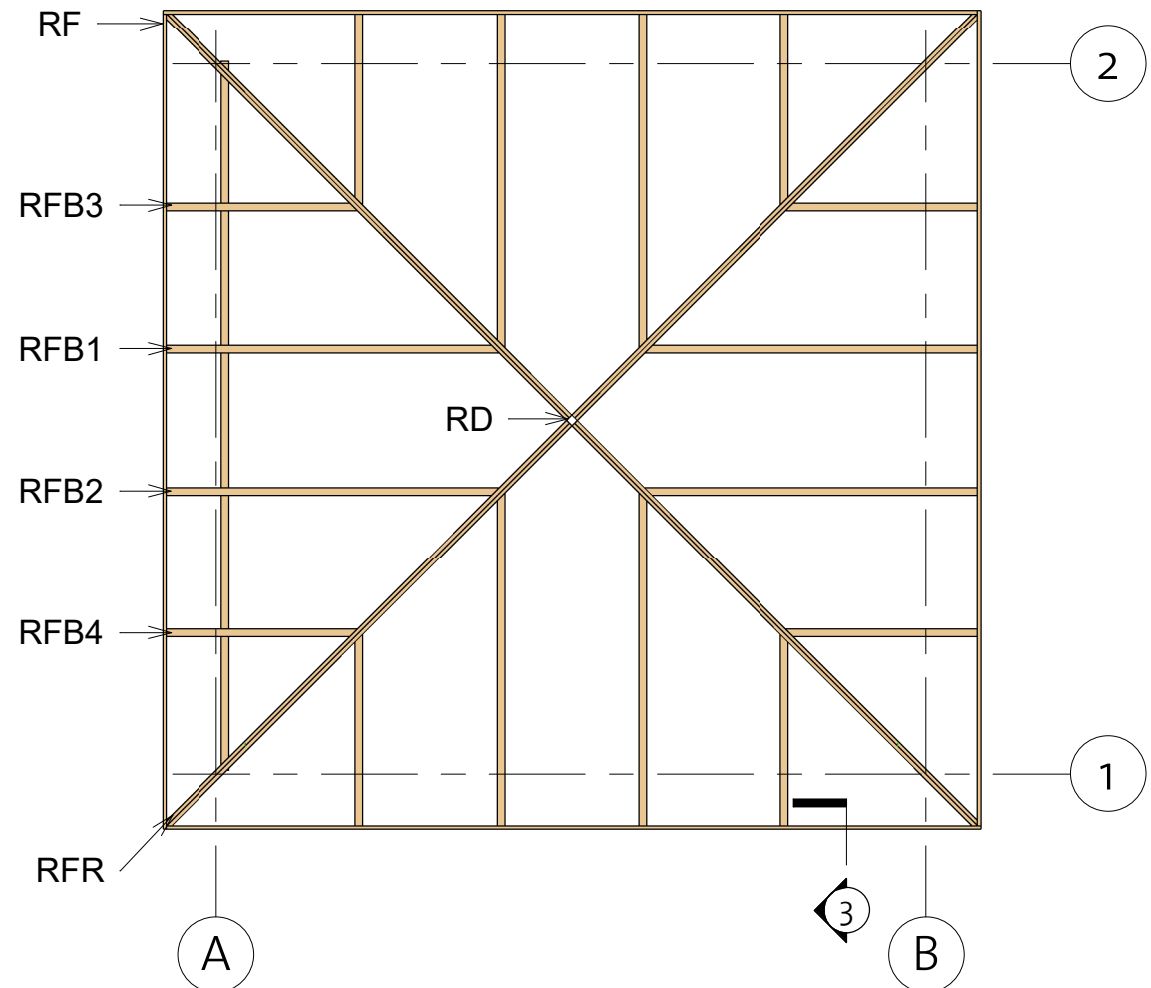
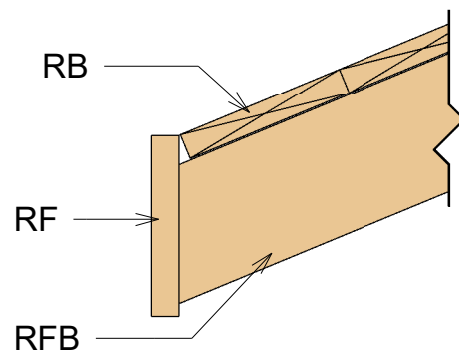

c.Arboga II 40 (380x380)

Extras

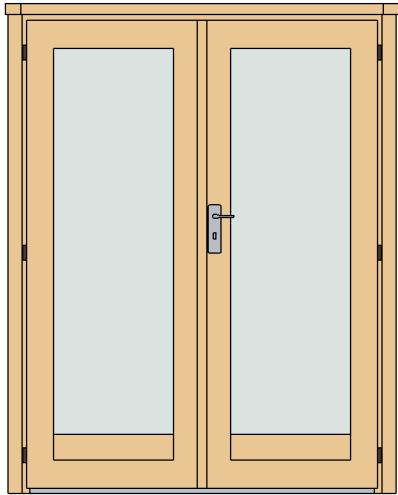

Door Schedule				
Model	Type	Width	Height	Count
CDD8R	Classic double door 8, full glass right	1425	1900	1

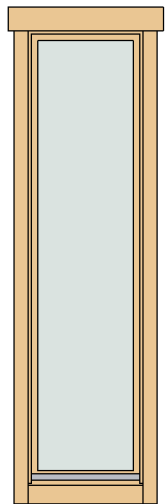

Window Schedule				
Model	Type	Width	Height	Count
CW3L	Classic window 3, full glass left	515	1890	2
CW3R	Classic window 3, full glass right	515	1890	2



Type	Count	Lenght
Windboard 18x40	5	2200

Roof Detdail		
Mark	Type	Count
RD	Roof detail	1



Fasteners/Extras		
Name	Type	Count

Hitblock	300-400 mm	
Bolts	M8 x 70	15
Nails	1,4 x 40	40
Screws	5,0 x 70	60
Screws	4,0 x 40	65
Screws	6,0 x 140	110
Screws	4,0 x 50	850

① Roof top

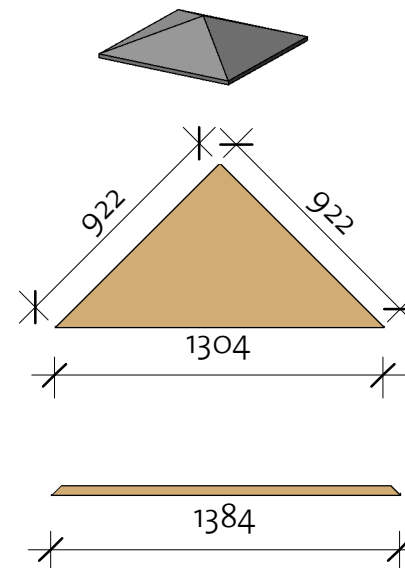

Type	Mark	Count
------	------	-------

Ceiling detail 40x120	CD	1
Ceiling triangle	CT	1

c.Arboga II 40 (380x380)

List of all items 1

Impregnated foundation beams

Mark	Type	Profile	Count	Length
------	------	---------	-------	--------

IFB1	IFB 40x70		7	3750
IFB2	IFB 40x70		1	3224
IFB3	IFB 40x70		1	2845
IFB4	IFB 40x70		1	2805
IFB5	IFB 40x70		2	1376

Floor Schedule

Mark	Type	Profile	Count	Length
------	------	---------	-------	--------

FB 1	FB 17x114		1	2861
FB 2	FB 17x114		1	2975
FB 3	FB 17x114		1	3089
FB 4	FB 17x114		1	3203
FB 5	FB 17x114		1	3317
FB 6	FB 17x114		1	3431
FB 7	FB 17x114		1	3545
FB 8	FB 17x114		1	3659
FB 9	FB 17x114		1	3717
FB 10	FB 17x114		25	3717

BB	BB 20x40		4	3800
----	-------------	---	---	------

c.Arboga II 40 (380x380)

List of all items 2



Wall 1			
Mark	Profile	Count	Cut Length

1LG-1	40x114	1	2841
1LG-2	40x114	32	554
1LG-3	40x114	16	693
1LG-4	40x114	1	4000
1LG-5	40x114	1	4000
1TL-1	40x63	3	711
1TL-2	40x63	1	725
1TL-3	40x63	1	725

Wall A			
Mark	Profile	Count	Cut Length

ATL-1	40x63	3	711
ATL-2	40x63	1	725
ATL-3	40x63	1	725
ABL-1	40x57	1	4000
ALG-1	40x114	18	4000
ALG-2	40x57 TL	1	4000

Log Profiles	
Profile	Profile

40x114	
40x63	

Wall 2			
Mark	Profile	Count	Cut Length

2LG-1	40x114	18	4000
2LG-2	40x114	1	4000
2TL-1	40x63	3	711
2TL-2	40x63	1	725
2TL-3	40x63	1	725

Wall B			
Mark	Profile	Count	Cut Length



BTL-1	40x63	3	711
BTL-2	40x63	1	725
BTL-3	40x63	1	725
BBL-1	40x57	1	2841
BLG-1	40x114	33	554
BLG-2	40x114	1	4000
BLG-3	40x114	1	651
BLG-4	40x114	17	693
BLG-5	40x57 TL	1	4000

Log Profiles	
Profile	Profile

40x57	
40x57 TL	

c.Arboga II 40 (380x380)

List of all items 3

Roof				
Mark	Type	Profile	Count	Length
RFR	40x94		4	3172
RFB4	40x85		4	1132
RFB3	40x85		4	1132
RFB2	40x85		4	1945
RFB1	40x85		4	1945

Roofboards				
Mark	Type	Profile	Count	Length
RB 1	RoofBoard 17x114		4	292
RB 2	RoofBoard 17x114		4	503
RB 3	RoofBoard 17x114		4	714
RB 4	RoofBoard 17x114		4	924
RB 5	RoofBoard 17x114		4	1135
RB 6	RoofBoard 17x114		4	1345
RB 7	RoofBoard 17x114		4	1556
RB 8	RoofBoard 17x114		4	1767
RB 9	RoofBoard 17x114		4	1977

Roofboards				
Mark	Type	Profile	Count	Length
RB 10	RoofBoard 17x114		4	2188
RB 11	RoofBoard 17x114		4	2399
RB 12	RoofBoard 17x114		4	2609
RB 13	RoofBoard 17x114		4	2820
RB 14	RoofBoard 17x114		4	3031
RB 15	RoofBoard 17x114		4	3241
RB 16	RoofBoard 17x114		4	3452
RB 17	RoofBoard 17x114		4	3663
RB 18	RoofBoard 17x114		4	3873
RB 19	RoofBoard 17x114		4	4084
RB 20	RoofBoard 17x114		4	4294

Fascia Schedule				
Mark	Type	Profile	Count	Length
RF	Roof Fascia 18x120		4	4314